

MODEL RT-40A RAIN SENSING WINDSHIELD WIPER CONTROL CONTROLS OFF THROUGH STEADY-SLOW SPEED (NO HIGH SPEED)

1. GET A WIRING DIAGRAM FOR YOUR VEHICLE

Go to www.raintracker.com and click on "Compatibility." Print out any special installations wiring diagrams that pertain to your car or truck. If the instructions refer to either the HSS or GSS diagrams included with this manual, write your specific vehicle wire colors on the diagram. If the instructions call for external components, they are usually included in the accessory kit.

3. LOCATE THE WIPER SYSTEM PARTS

You will likely need to remove access panels. You can often trace wires from the switch or motor, or listen for clicking relays when the wiper system is in intermittent mode.

2. TEST THE EXISTING WIPER SYSTEM

Make sure that the existing wiper system works in off, intermittent (if so equipped), slow, and fast modes of operation, and that the wash motor works.

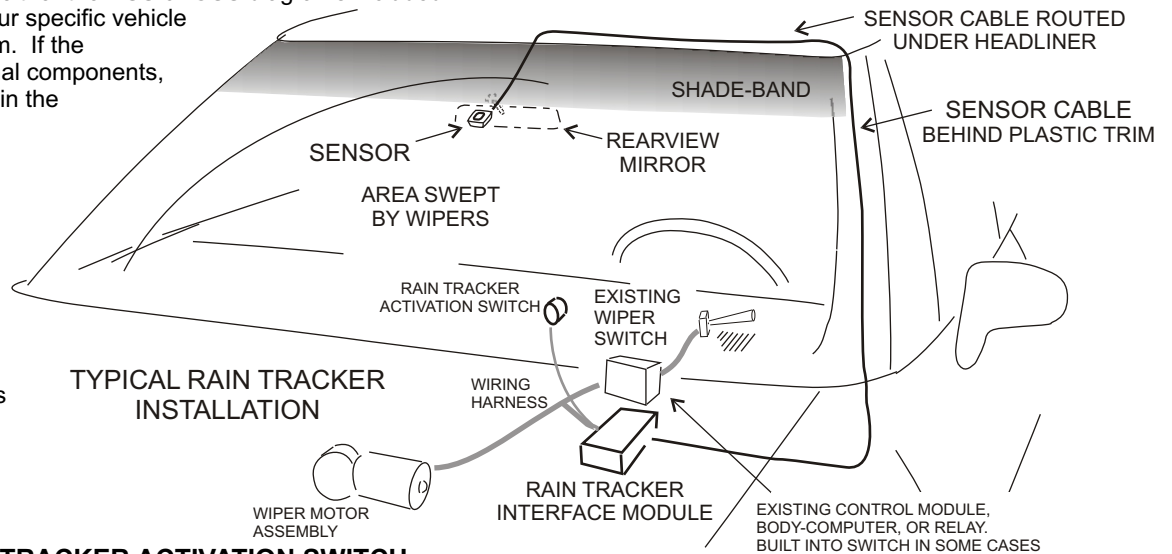

4. MOUNT THE RAIN TRACKER ACTIVATION SWITCH

The supplied round activation switch turns the Rain Tracker on to default sensitivity. Mount the switch before you connect the switch wires to the Rain Tracker. Select a mounting location in a dash knock-out panel, or in an under-dash panel (available at auto parts store.) To mount the round

activation switch, drill a hole (5/8 inch or 3/4 inch depending on switch model supplied) and file the hole slightly larger until the switch can press in appropriately. File a locating notch as needed. Other styles of (SINGLE POLE) switches are available from Radio Shack and other suppliers.

5. INSTALL THE RAIN TRACKER INTERFACE MODULE

Make sure the location you select for the module will not conflict with the operation of any equipment, such as accelerator or brake cables. Use the wiring diagram as a guide in connecting the Rain Tracker interface module into the existing wiper system. See last pages for tips on making connections.

5A. MAKE THE INTERFACE CONNECTIONS

Connect the wires as shown in the diagram. If the diagram requires that you make a chassis ground connection, find a suitable metal frame member and screw, and make sure that it is free of paint. Bad grounds are the most common problems we encounter when troubleshooting Rain Tracker installations.

5B. PLUG IN THE INTERFACE MODULE

Plug in the interface connector so that its locking ramp engages the locking ramp on the interface module. The BLK ground wire should be closest to the sensor Jack, J1. **DO NOT PLUG THE INTERFACE MODULE CONNECTOR IN UPSIDE-DOWN.**

6. INSTALL THE SENSOR

Select a coupler mounting location within the area swept by the wipers, and out of the shadeband. Just below the mirror mount is usually a good location. *Tip: mark the location with a piece of masking tape on the outside of the windshield, and stand back from the vehicle to make sure the mark is level.*

Prime the sensor mounting location with isopropyl alcohol. **Do not skip this step!** Un-snap the coupler from the sensor.

7. INSTALL THE SENSOR CABLE

Connect one end of the sensor cable to the sensor, and route the cable under the head liner and down the vehicle's trim to connect it to the interface module.

8. SECURE THE INTERFACE MODULE

Use cable ties to secure the interface module to a bracket or convenient location. Reinstall access panels as needed.

9. TEST THE RAIN TRACKER SYSTEM WITH A SPRAY BOTTLE OR GARDEN HOSE

Turn the ignition to accessory mode. Use the wiper control switch to verify that all manual modes (off, slow, fast, and wash) work. Put the system in Rain Tracker mode by turning on the activation switch. Spray a light mist at the sensor and verify that the Rain Tracker runs the wipers in intermittent mode. Spray more water and confirm operation in steady slow speed.

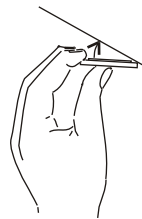

Remove the red protective film from the coupler, and rock the coupler onto the windshield.

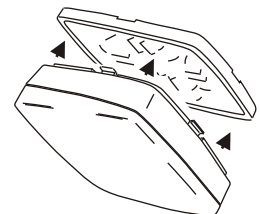

Snap the sensor into the coupler.

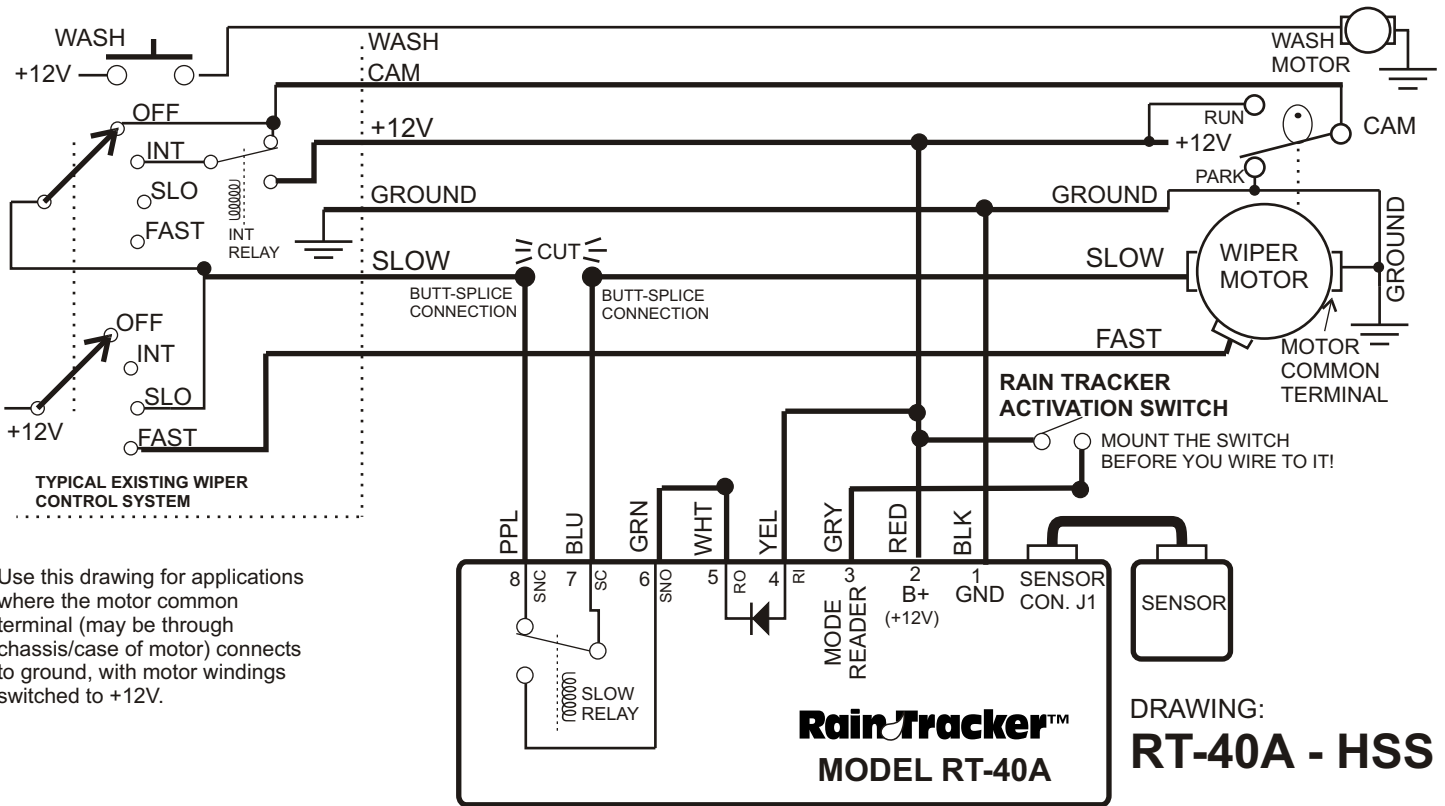

RAIN TRACKER RT-40A IN HOT-SIDE SWITCHING APPLICATIONS (MOST COMMON)

FOR VEHICLE-SPECIFIC WIRE COLORS AND DETAILED WIRING DIAGRAMS, GO TO WWW.RAINTRACKER.COM. CLICK ON "COMPATIBILITY."

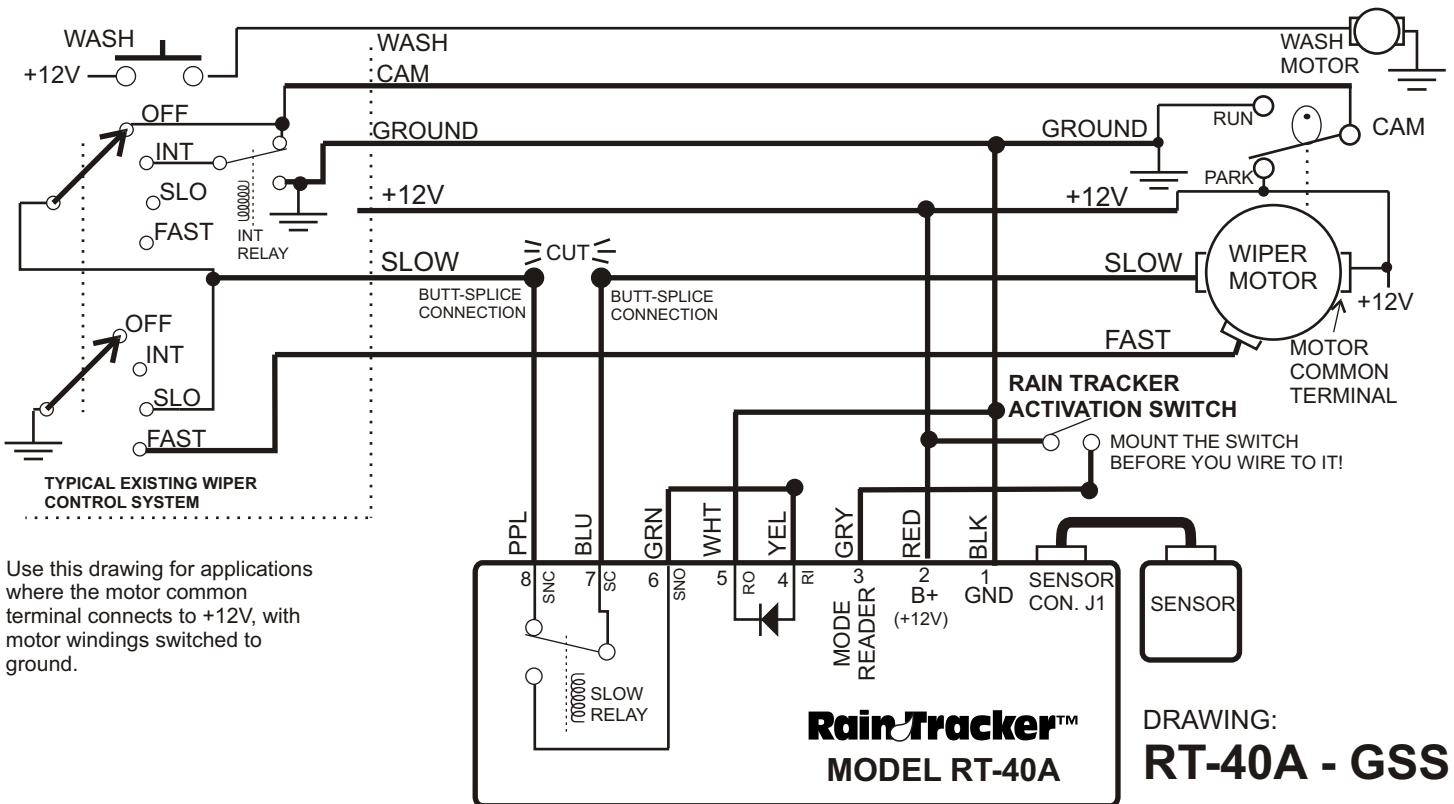

RAIN TRACKER RT-40A IN GROUND-SIDE SWITCHING APPLICATIONS

TROUBLESHOOTING: SENSOR SENSITIVITY ISSUES

WIPES TOO MUCH

Make sure the Rain Tracker is in an area that is being completely cleared by the wipers. Sometimes at the edges of wipe patterns the wipers leave a film of water, and this will make the Rain Tracker wipe too much. Also, worn wiper blades will cause excessive follow-up wipes.

WILL NOT SENSE RAIN OR WIPES TOO LITTLE

Make sure the Rain Tracker coupler is properly mounted to the windshield, and is reasonably free of air bubbles. Note that the Rain Tracker will not see through the red tape- the coupler must be mounted to the glass. Also, the glass just over the sensor should be free from RAIN-X or other windshield treatments.

TROUBLESHOOTING: VEHICLE INTERFACE ISSUES

Check Ground First - Check that the Rain Tracker is getting a good ground. Use a multi-meter to verify that the resistance between the black ground wire on the Rain Tracker interface connector and the vehicle chassis is less than two ohms.

One or more manual modes (Off, Slow, Fast, Wash) does not work - If so, then the problem is in the interface wiring, not the sensor.

Wipers still run after you stop spraying water at it - This is to remove water that may blow off the hood onto the windshield, but miss the sensor. When you spray the Rain Tracker with a spray bottle, it will appear to accelerate too slowly, and keep going too long. When you drive with the Rain Tracker in a real rain storm, it will respond appropriately to changing conditions, and will not appear jerky or erratic.

Wipers stop in middle of windshield, or will not run manual slow:

Check the wiring to J2 pin 8 (PPL)

Manual fast is slower than it used to b: Be sure you do not wire the system in some way that applies power to both fast and slow windings with no blocking diode.

ADJUSTING THE SENSITIVITY (RARELY NEEDED!)

The Rain Tracker adjusts itself for the windshield of your car and typically requires no adjustments. The sensitivity adjustment is to account for driver preference; the Rain Tracker is a very high quality product, thoroughly tested, and unit variation is low. Consider carefully before adjusting the sensitivity-- the wiper response rate is appropriate for most drivers and vehicles. Inappropriately high sensitivity can lead to more smearing, and is usually not better. The Rain Tracker increases the sensitivity slightly at night, when most drivers want higher sensitivity, and decreases the sensitivity in bright sunlight, when sensed water is often due to road spray. It decreases the sensitivity slightly in cold weather, to prevent over-wiping.

But if you still want to adjust the sensitivity, the sensor itself may be adjusted. There is a trimmer potentiometer on the sensor, and a qualified technician can adjust this with the aid of a tiny screwdriver. The potentiometer ships from the factory at nominal. For more sensitivity, adjust this about 20% clockwise. For less sensitivity, go 20% counter clockwise. Move this just a little at a time.

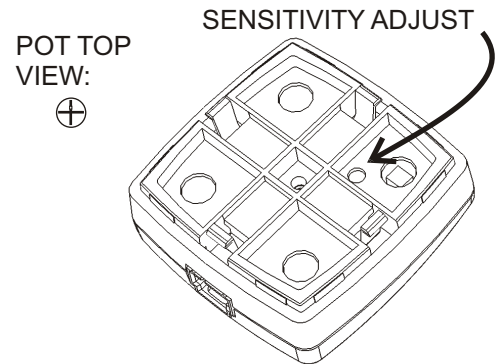

OPTIONAL HIGH SPEED / HEADLAMP CONTROL

The Rain Tracker model RT-40A does not automatically control the wipers in high speed mode, nor does it automatically control the headlamps. See www.raintracker.com for models with these features.

TIPS ON MAKING GOOD INTERFACE CONNECTIONS

CRIMPING INSTRUCTIONS-- ALL CRIMPS

Use a crimp tool and apply enough force. Twist wire strands together after stripping, and avoid broken strands. Always check each crimp with a gentle tug on the wire to make sure it will not come undone.

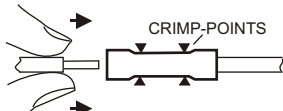

BUTT SPLICES

To connect a single wire to another single wire. Strip off 3/8" from end of wire. Slide wire into terminal barrel as far as it will go.

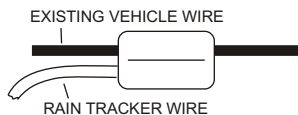

NO-STRIP TEE SPLICES

Use the blue tee-splices to connect a single Rain Tracker interface wire to an existing heavy gage (16 or 18) vehicle wire, or to connect Rain Tracker wires to each other. Use a slip-joint pliers to close the splice over the wire. Also: NMEDA guidelines prohibit these connectors in mobility-enabled applications.

RESISTORS have three colors and then a gold band that signifies 5% tolerance.

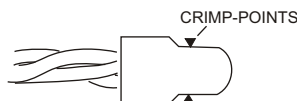

CLOSED-END TEE SPLICES

To connect three to five wires to each other. Strip 1/2" from the end of each wire. Twist the wires together and slide them all into the barrel of the terminal.

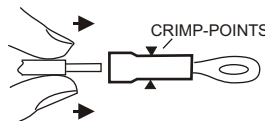

GROUND CONNECTIONS

If the wiring diagram calls for a connection to ground that is not through one of the vehicle wires, be sure to provide a solid ground. (Bad grounds are the most common wiring problem we encounter.) Use the ring terminal to a screw or bolt that runs into a metal part of the chassis. Alternatively, you may be able to find an existing vehicle wire that provides a good ground. The ground side of the cigarette lighter is often a good candidate.

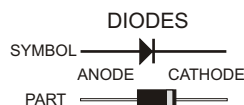

SEPARATING WIRES IN A RIBBON CABLE

To connect to vehicle wires in a ribbon cable, separate them first. Use a single edge razor blade or a utility knife, with many light passes. Be careful not to damage the wires!

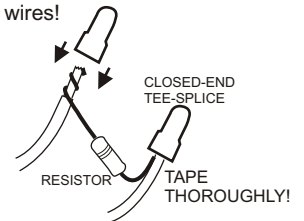

EXTERNAL RESISTORS OR OTHER COMPONENTS

If a vehicle interface requires an external resistor or other component: 1) Strip 3/8" from the ends of the connecting wires. 2) Twist the ends of each of the resistor leads around the wires. 3) Crimp a closed-end tee splice over the connection. 4) Wrap electrical tape around the connection assembly, and tape the two connecting wires together.

HOW THE RAIN TRACKER RT-40A INTERFACE WORKS

ACTIVATION - The RT-40A is turned ON by connecting the mode reader (J2 Pin 3, GRY) is to +12V

MANUAL MODES - The RT-40A Rain Tracker relies on the existing wiper system to operate the wipers in manual slow, fast, intermittent, or wash.

AUTOMATIC INTERMITTENT MODE - When the RT-40A commands the system to wipe intermittently, the slow relay pulses on. The fast relay remains off.

AUTOMATIC STEADY SLOW MODE - The RT-40A turns on the slow relay and leaves the fast relay off.

BLOCKING DIODE- The built-in rectifier (J2 pins 4 and 5) is provided so that no Rain Tracker application ever shorts fast and slow windings together, which would cause an over-current condition.

WIPER PATTERN COMPATIBILITY

In most vehicles, the wipers move from side to side in tandem, making it easy to mount the Rain Tracker sensor out of view, behind the rearview mirror.

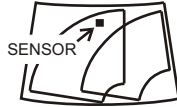

TANDEM WIPE PATTERN
(TYPICAL INSTALLATION)

Some vehicles use a center-out wipe pattern. The Rain Tracker needs to be in the area swept by the wipers. It will not work if mounted behind the rearview mirror on these vehicles. You can locate the sensor between the wipers when they are out of the park position, or up in a corner of the windshield near the pillars-- but an inch and half away enough from the edge of the pattern so the wipers do not leave a film of water.

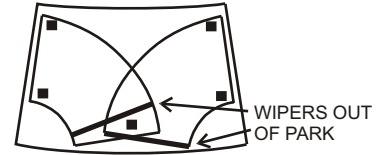

CENTER OUT-WIPE PATTERN
ALTERNATIVE SENSOR LOCATIONS

WINDSHIELD COMPATIBILITY

The Rain Tracker will work on almost all windshields used in cars and light trucks sold in the US. The Rain Tracker will work with all commonly available thicknesses and windshield tints, from clear glass to high performance solar absorbing glass. Choose a mounting location that is not deep within the shade-band.

The Rain Tracker will not work on (relatively rare) solar-reflective windshields. (E.g. "Sun-Gate", KOOL-LOF) You can identify a film coated windshield by looking for the edge of the film coated region, which usually ends about an inch from the edges of the windshield. Sometimes these windshields have a non-coated region where you can mount the Rain Tracker sensor. The Rain Tracker RT-50A will work on windshields up to 12 mm / 0.47" thick-- generally well above that required for even recreational vehicles and heavy trucks.

RAIN TRACKER SPECIFICATIONS:

Wiper relay contact ratings: 15A
Power diode rating: 6A continuous (used only intermittently in application)
Input voltage: 10 - 16V, 12V nominal. 24V overvoltage protected.
Sensor operation: invisible infrared beams (880 nM)
Windshield thickness: 0.12" - 0.47" (3 - 12 MM)
Windshield transmittance requirement: 12% - 100% at 880 nM
Mechanical: Sensor: 1.75" x 1.75" x .75" / 1 oz.
Interface module: 4.45" x 2.45" x 1.15" / 4 oz.

TRADEMARKS, COPYRIGHTS, AND PATENTS

"Rain Tracker" is a trademark of Opto-Electronic Design, Inc. Other trademarks are properties of their respective owners. This manual is copyright 2001-2008 Opto-Electronic Design, Inc. No portion of this document may be reproduced without the express written permission of Opto-Electronic Design, Inc. The Rain Tracker product is protected by one or more of the following US Patents:

4,620,141 5,059,877 5,239,244 5,262,640 5,556,493 5,568,027
5,743,991 5,898,183 6,078,056 6,091,065 6,124,691

CONTACT INFORMATION

Questions? Comments? Concerns? Compliments? Criticism?
Please contact us:

In the US and Europe:
Opto-Electronic Design, Inc.
6440 Flying Cloud Drive, Suite 207
Eden Prairie, MN 55344
www.oedes.com - E-mail: info@oedes.com
Phone: (952) 943-2378 Fax: (952) 943-1020
Toll free: 1-888-621-5800

In South-East Asia:
XENSO Group Sdn. Bhd.
No.49, Jalan Taboh 33/23,
Shah Alam Technology Park,
Section 33, 40400 Shah Alam,
Selangor, Malaysia.
Tel : +603 - 5122 9266, 5122 7266, 5122 0063
Fax: 603-5122 4300
www.xenso.com.my

WARRANTY

RAIN TRACKER THREE YEAR LIMITED WARRANTY

Opto-Electronic Design, Inc. (OEDES) warrants to the original purchaser that this Rain Sensing Windshield Wiper Control is free of defects in materials and workmanship under normal use and maintenance for a period of three (3) years from the date of original purchase, whether or not actual use begins on that date. User however, is responsible for removal, packaging, and transportation of product to OEDES.

LABOR IS NOT COVERED.

If the Wiper Control fails within the three (3) year period, it will be repaired or replaced during normal working hours, at OEDES's option, at no charge, when returned prepaid to OEDES with Proof of Purchase. The sales receipt may be used for this purpose. All replacement parts, whether new or re-manufactured, assume as their warranty period only the remaining time of this warranty.

This warranty does not apply to damage caused by improper installation, accident, misuse, abuse, improper voltage, service, flood, lightning, vehicle accident or other acts of God, or if the product was altered or repaired by anyone other than OEDES. OEDES does not warrant installation of the Wiper Control (labor) and therefore will not be responsible for installation or re-installation charges. OEDES under no circumstances shall be liable for any consequential damages for this unit.

This warranty gives you specific legal rights, and you may also have rights which vary from state to state.